



PREMIUM

Blending Equipment









SMARTER Investment

You only want the best in your kitchen, behind your counter, and for your customers. You won't accept anything less—not from yourself, and not from the equipment you count on, every day, to perform. That's why chefs and foodservice professionals trust Vitamix. They know it's not just a blender; it's an essential part of their success.



Table of Contents

4.	<u>Commercial Products</u>	
8.	<u>Covered Beverage Blenders</u>	
12.	<u>Uncovered Beverage Blenders</u>	
16.	<u>Food Preparation Blenders</u>	
22.	<u>Frozen Treat Mixers</u>	
26.	<u>Containers</u>	
38.	<u>Accessories & Parts</u>	
48.	<u>Ordering Information</u>	



COMMERCIAL

Products

Food or beverage, front of house or back, there's a Vitamix machine to suit your menu and your batch sizes. And now, finding the right machine has never been easier. We've divided our machines into categories according to application, so you can quickly identify which product might be right for your business.



COVERED BEVERAGE BLENDERS

Reduce blending noise for superior customer experience

Up to 34 recipe programs to automate blending

Advance containers offer maximum efficiency and dripless spouts

To view machines, refer to the Covered Beverage Blenders section



UNCOVERED BEVERAGE BLENDERS

Variety of control options and container sizes to choose from

Up to 6 optimized programs with automatic shut-off

Recommended for a wide range of blends, from smoothies to frozen drinks to açai bowls

To view machines, refer to the Uncovered Beverage Blenders section



FOOD PREP BLENDERS

Powerful efficiency to shorten prep times in Back of House (BOH) applications

Variable Speed Control achieves precise textures in every dish

Tamper allows continuous blending and tackles dense ingredients

To view machines, refer to the Food Preparation Blenders section



FROZEN TREAT MIXERS

Incorporate mix-ins into frozen desserts

Standard or programmed models available

Variety of agitators to choose from

To view machines, refer to the Frozen Treat Mixers section

Explore what we can do together



Technique:

BLENDING

The speed of the Vitamix blades fully incorporates ingredients, including ice and frozen fruits, for signature, hand-crafted blends. Depending on your machine's controls, use pre-programmed settings to achieve consistent results, or 93 variable speeds to adjust the mouthfeel of every drink.



Technique:

CHOPPING

Using the Pulse or On/Off switch, you can deliver a few quick bursts of power to rough chop ingredients, creating chunky dips and sauces without knife work. Instead of a food processor with limited controls, a Vitamix blender gives you a full range of speeds to refine the size of every chop.



Technique:

HEATING

With the Vitamix machine's ability to heat ingredients through friction, soups and sauces can typically be brought to 170°F in just 5 minutes of blending on High. Use that power to your advantage when creating delicate custards and sauces, instead of risking scorching them in a double boiler.



Technique:

HOMOGENIZING

Frozen ingredients are quickly homogenized in the container's vortex, with no chunks left behind. Vitamix machines allow you to create a wide range of recipes that would otherwise be too time-consuming, since you can blend housemade desserts in a single process and serve immediately.



Technique:

GRINDING

Grind and pulverize virtually any ingredient to create every menu item from scratch without added oil, sugar, or shelf stabilizers. Transform roasted nuts to perfectly smooth butter and freeze-dried berries to the lightest powders — a wide variety of textures that just aren't possible with another appliance.



Technique:

EMULSIFYING

By pouring oil slowly through the lid plug opening, emulsifications are created in seconds. Even new prep cooks can master this technique to create simple vinaigrettes, hollandaise sauce, and more.



Technique:

CREAMING

Creating fluffy, creamy textures in your Vitamix container will save your pastry chef time and money. There's no need to sift ingredients — the blender's speed breaks up clumps and fully incorporates ingredients for perfect creamed recipes.



Technique:

PURÉEING

In a single process, the Vitamix blender delivers exceptional texture and flavor refinement that typically requires additional steps like straining through a chinois. Easily adjust speed to control mouthfeel and create everything from a textured dip to a silky smooth purée.



Technique:

INFUSING

Take handcrafted cocktails to the next level by creating your own flavored simple syrups, right in the blender. Just add mint, citrus zest, or spices to your simple syrup made in the blender and pulse a few times to marry the flavors.



Technique:

MUDDLING

Let your Vitamix blender do the prep work for you. Pulsing lets you quickly rough chop items like fresh herbs to release their essential oils and create a great muddled drink. Add the perfect finishing touch by grinding your own sugar or salt for distinctive glass rims.



Technique:

WHIPPING

Blend heavy cream with chosen flavorings (such as mint or chocolate) on high speed until soft peaks form. Or create an indulgent mousse as your main dessert course by whipping the cream and folding in flavorings that have been blended separately.



Technique:

WHOLE JUICING

For smoothie and juice bars, a fresh juice blend is packed with flavor. And Vitamix blends the whole ingredient — for more fiber and less waste. Simply blend fruit and vegetable ingredients with water to your desired consistency. These fresh juices are also a great addition to your bar and restaurant menus.



COVERED BEVERAGE

Blenders



THE QUIET ONE	TOUCH & GO ADVANCE
----------------------	-------------------------------

*Our quietest blender, most trusted
by the world's largest chains*

*Noise reduction for
smaller volume shops*

<i>Applications</i>	Ideal for double and triple batches of smoothies, frappes, juices, milkshakes, and cocktails	Ideal for any blended beverage, including smoothies, frappes, juices, milkshakes, and cocktails
<i>Motor</i>	≈ 3 hp	≈ 2.3 hp
<i>Included Container</i>	48-ounce Advance Container with Advance blade	32-ounce Advance Container with Advance blade
<i>Controls</i>	34 pre-programmed recipe settings to customize your 6-button control panel	20 pre-programmed recipe settings to customize your 6-button control panel
<i>Automated Processing</i>		
<i>Programmable</i>	Programmable with kit (sold separately)	
<i>Speeds</i>	93 variable speeds allow flexibility during manual processing	
<i>Pulse</i>	High / Low Pulse	High / Low Pulse
<i>Accessories</i>	48- or 32-ounce Advance Containers 48- or 32-ounce Standard Containers 32-ounce Aerating Container	32-ounce Advance Containers 32-ounce Aerating Container 48- or 32-ounce Standard Containers

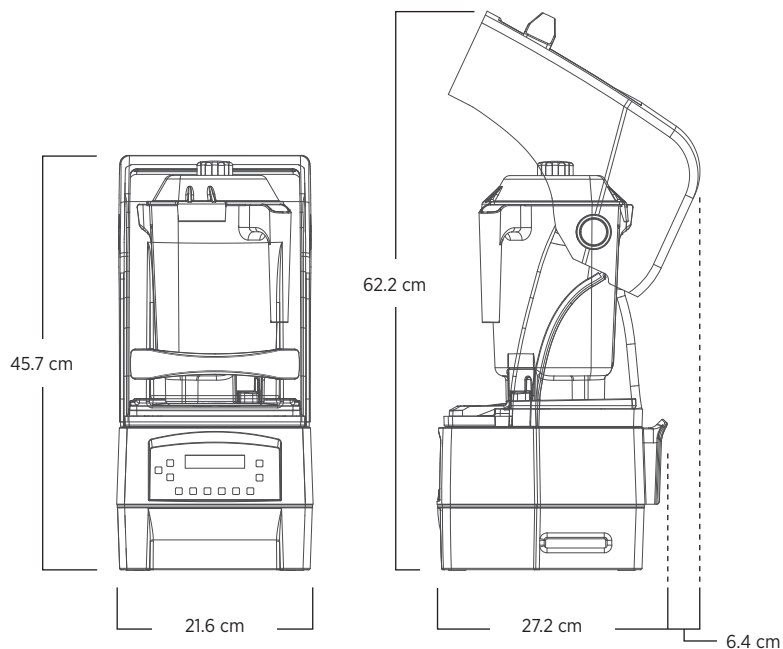

ITEM #	DESCRIPTION
36019	The Quiet One with 48 oz. / 1.4 L BPA-Free, clear / stackable. Advance container complete with Advance blade assembly and lid, removable compact twist lock cover, and 34 programs

SPECIFICATIONS:

Programs: 34

Motor: ≈ 3 peak output horsepower motor

Electrical: 120 V, 50/60 Hz, 15.0 A

Container & Blade: 48 oz. / 1.4 L container complete with Advance blade assembly and lid

Dimensions (H x W x D):

18.0 x 8.5 x 10.7 in. / 45.7 x 21.6 x 27.2 cm

Height with lid open: 24.5 in. / 62.2 cm

Certifications: 

SHIPPING:

Pack: 1 per standard pack

Carton Dimensions (H x W x D):

19.37 x 11.87 x 13 in. / 49.21 x 30.16 x 33.02 cm

Weight: 23.1 lbs.

Case Cube: 2.3 cu. ft. / 0.07 cu. m

WARRANTY: The Quiet One is backed by a three-year warranty on motor base parts and a one-year warranty on labor. For more complete warranty terms and conditions, please call 1.800.437.4654 or visit vitamix.com.

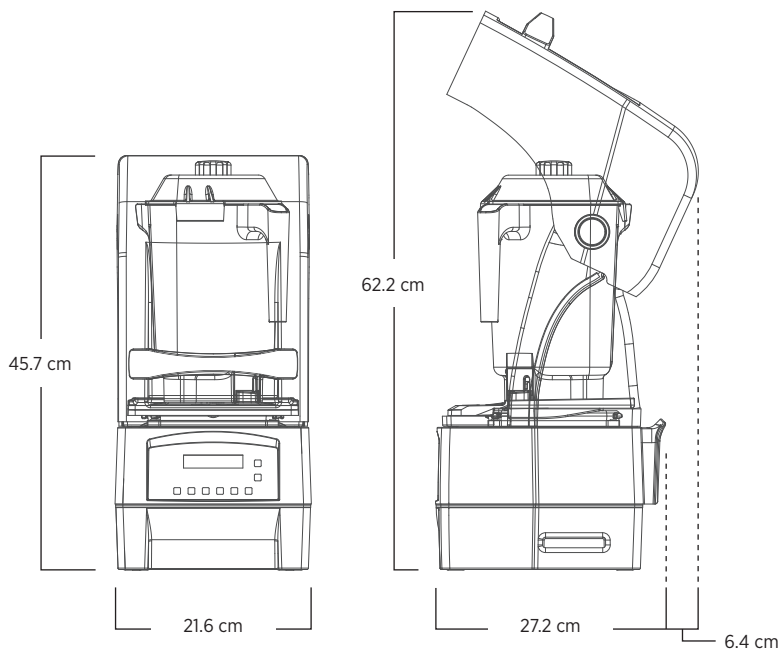

ITEM #	DESCRIPTION
068255	Touch & Go Advance with 32 oz. / 0.9 L BPA-Free, clear / stackable Advance container complete with Advance blade assembly and lid, and removable compact twist lock cover*, and 20 programs

SPECIFICATIONS:**Programs:** 20**Motor:** ≈2.3 peak output horsepower motor**Electrical:** 120 V, 50/60 Hz, 12.0 A**Container & Blade:** 32 oz. / 0.9 L container complete with Advance blade assembly and lid**Dimensions** (H x W x D):

18.0 x 8.5 x 10.8 in / 45.7 x 21.6 x 27.3 cm

Height with lid open: 24.5 in / 62.2 cm

Certifications: **SHIPPING:****Pack:** 1 per standard pack**Carton Dimensions** (H x W x D):

19.37 x 11.87 x 13.0 in / 49.21 x 30.16 x 33.02 cm

Weight: 23.1 lbs**Case Cube:** 2.3 cu. ft. / 0.1 cu. m**WARRANTY:** The Touch & Go Advance is backed by a three-year warranty on motor base parts and a one-year warranty on labor. For more complete warranty terms and conditions, please call 1.800.437.4654 or visit vitamix.com.



UNCOVERED BEVERAGE

Blenders



DRINK MACHINE™ ADVANCE®	DRINK MACHINE™ 2 SPEED
--------------------------------	-------------------------------

Six blending programs offer custom capabilities for every menu

Easy-to-use controls for consistent drink quality

<i>Applications</i>	Ideal for any blended beverage, including smoothies, frappés, juices, milkshakes, and cocktails	Ideal for açai bowls, sorbets, and green smoothies
<i>Motor</i>	≈2.3 hp	≈2.3 hp
<i>Included Container</i>	48-ounce Advance Container with Advance blade	64-ounce Standard Container with wet blade
<i>Tamper</i>		Tamper
<i>Controls</i>	6 programs deliver fast and consistent high-quality beverages	
<i>Automated Processing</i>		
<i>Programmable</i>	Programmable with kit (sold separately)	
<i>Speeds</i>		High/Low
<i>Pulse</i>	Pulse	
<i>Accessories</i>	48- or 32-ounce Advance Containers 48- or 32-ounce Standard Containers	64 ounce Standard Containers 48- or 32-ounce Standard Containers

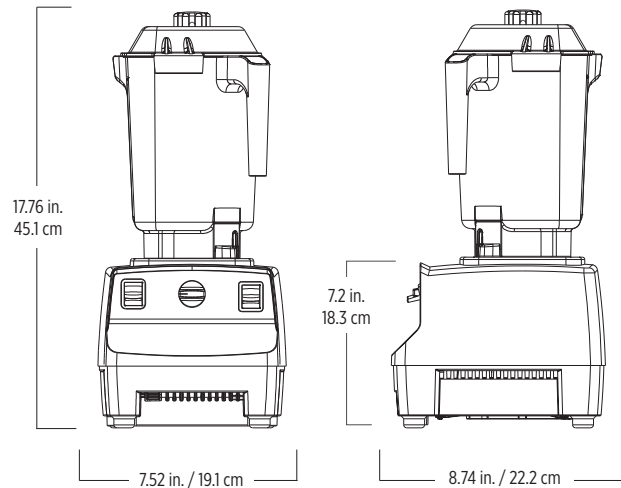

ITEM #	DESCRIPTION
62824	Drink Machine Advance with black base, 48 oz. / 1.4 L BPA-Free, clear / stackable Advance container complete with Advance blade assembly and lid. Includes 6 pre-loaded programs.
62825	Drink Machine Advance with red base, 48 oz. / 1.4 L BPA-Free, clear / stackable Advance container complete with Advance blade assembly and lid. Includes 6 pre-loaded programs.

SPECIFICATIONS:

Programs: 6

Motor: ≈2.3 peak output horsepower motor

Electrical: 120 V, 50/60 Hz, 11.5 A

Container & Blade: 48 oz. / 1.4 L container complete with Advance blade assembly and lid

Dimensions (H x W x D):
17,76 x 7,52 x 8,74 in / 45,1 x 19,1 x 22,2 cm

Certifications: 

SHIPPING:

Pack: 1 per standard pack

Carton Dimensions (H x W x D):
13.1 x 11.9 x 16.9 in. / 33.3 x 30.2 x 42.9 cm

Weight: 13.54 lbs.

Case Cube: 1.5 cu. ft. / 0.04 cu. m

WARRANTY: The Drink Machine Advance is backed by a three-year warranty on motor base parts and a one-year warranty on labor. For more complete warranty terms and conditions, please call 1.800.437.4654 or visit vitamix.com.

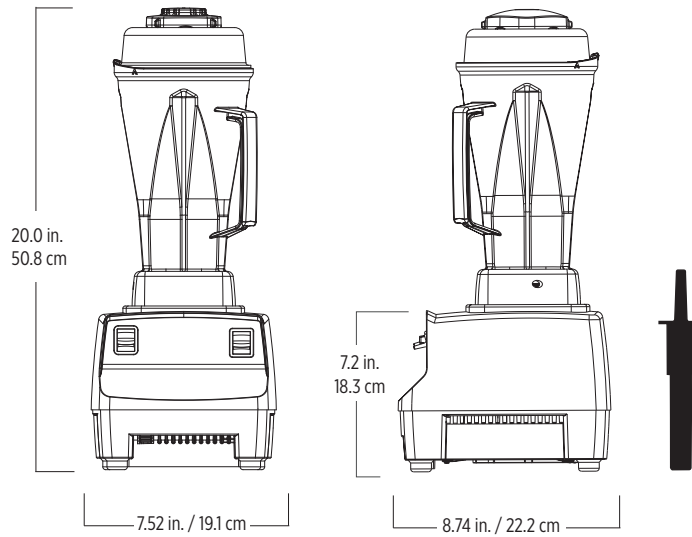

ITEM #	DESCRIPTION
62828	Drink Machine Two-Speed with 64 oz. / 2.0 L BPA-Free, clear standard container complete with wet blade assembly and lid, tamper, and black base.

SPECIFICATIONS:

Motor: ≈2.3 peak output horsepower motor

Electrical: 120 V, 50/60 Hz, 11.5 A

Container & Blade: 64 oz. / 2.0 L standard container complete with wet blade assembly and lid

Dimensions (H x W x D):
20.0 x 7.52 x 8.74 in / 50.8 x 19.1 x 22.2 cm

Certifications: 

SHIPPING:

Pack: 1 per standard pack

Carton Dimensions (H x W x D):
3.1 x 11.9 x 16.9 in. / 33.3 x 30.2 x 42.9 cm

Weight: 11.0 lbs.

Case Cube: 1.5 cu. ft. / 0.04 cu. m

WARRANTY: The Drink Machine Two-Speed is backed by a three-year warranty on motor base parts and a one-year warranty on labor. For more complete warranty terms and conditions, please call 1.800.437.4654 or visit vitamix.com.



FOOD PREP

Blenders



VITA-PREP[®] 3

VITA-PREP[®]

VITAMIX XL[®]

Exceptional power, versatility, and performance for the most demanding kitchens

Dependable BOH tool to simplify prep work

Our most powerful, largest capacity machine for maximum efficiency

Applications	For difficult back-to-back blending, chopping, puréeing, emulsifying, heating, grinding	Blending, chopping, puréeing, emulsifying, heating, grinding	Large-volume batches, ground proteins, ice cream and gelato bases, aerated batters and whipped creams, dressings and vinaigrettes
Motor	≈3 hp and larger cooling fan	≈2.3 hp	≈4.2 hp
Included Container	64-ounce Standard Container with wet blade	64-ounce Standard Container with wet blade	1.5-gallon XL Container with XL blade and 64-ounce XL Container with XL blade Also available in a 1.5 g container only package
Tamper	Tamper	Tamper	Tamper
Controls	Variable Speed Control	Variable Speed Control	Variable Speed Control Model and Programs Model available
Variable Speeds			
Pulse			Pulse
Accessories	64-, 48- or 32-ounce Standard Containers 32-ounce Aerating Container	64-, 48- or 32-ounce Standard Containers 32-ounce Aerating Container	1.5 g XL Container 64 ounce XL Container

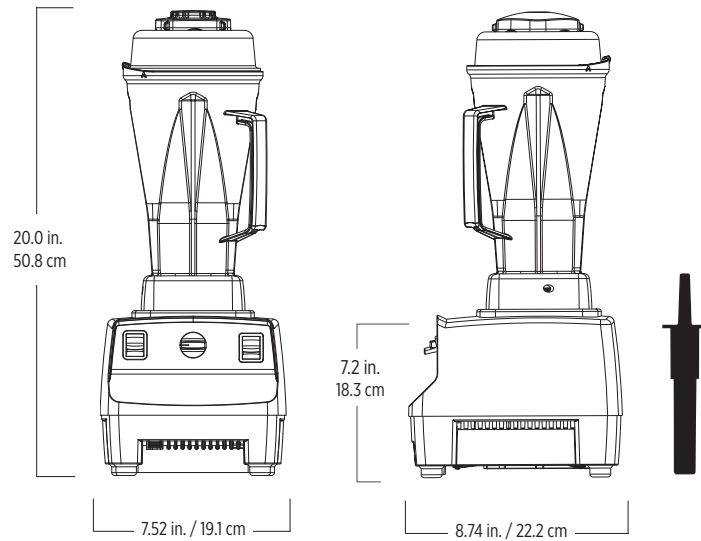

ITEM #	DESCRIPTION
62826	Vita-Prep 3 with 64 oz. / 2.0 L BPA-Free, clear container complete with wet blade assembly, lid, tamper, and black base.

SPECIFICATIONS:

Motor: ≈3 peak output horsepower motor

Electrical: 120 V, 50/60 Hz, 13 A

Container & Blade: 64 oz. / 2.0 L container complete with wet blade assembly and lid

Dimensions (H x W x D):
20.0 x 7.52 x 8.74 in / 50.8 x 19.1 x 22.2 cm

Certifications: 

SHIPPING:

Pack: 1 per standard pack

Carton Dimensions (H x W x D):
13.1 x 11.9 x 16.9 in. / 33.3 x 30.2 x 42.9 cm

Weight: 13.8 lbs.

Case Cube: 1.5 cu. ft. / 0.04 cu. m

WARRANTY: The Vita-Prep 3 is backed by a three-year warranty on motor base parts and a one-year warranty on labor. For more complete warranty terms and conditions, please call 1.800.437.4654 or visit vitamix.com.

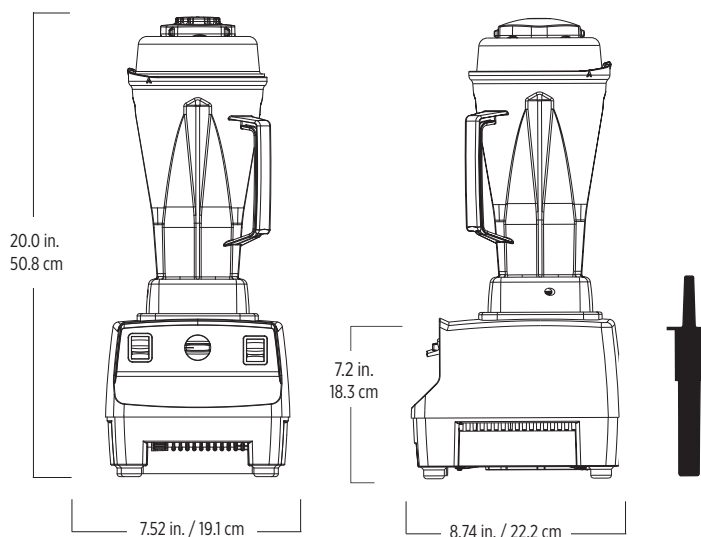

ITEM #	DESCRIPTION
62827	Vita-Prep with 64 oz. / 2.0 L BPA-Free, clear container complete with wet blade assembly, lid, tamper, and black base

SPECIFICATIONS:

Motor: ≈2.3 peak output horsepower motor

Electrical: 120 V, 50/60 Hz, 11.5 A

Container & Blade: 64 oz. / 2.0 L container complete with wet blade assembly and lid

Dimensions (H x W x D):
20.0 x 7.52 x 8.74 in / 50.8 x 19.1 x 22.2 cm

Certifications: 

SHIPPING:

Pack: 1 per standard pack

Carton Dimensions (H x W x D):
13.1 x 11.9 x 16.9 in. / 33.3 x 30.2 x 42.9 cm

Weight: 13.8 lbs.

Case Cube: 1.5 cu. ft. / 0.04 cu. m

WARRANTY: The Vita-Prep is backed by a three-year warranty on motor base parts and a one-year warranty on labor. For more complete warranty terms and conditions, please call 1.800.437.4654 or visit vitamix.com.

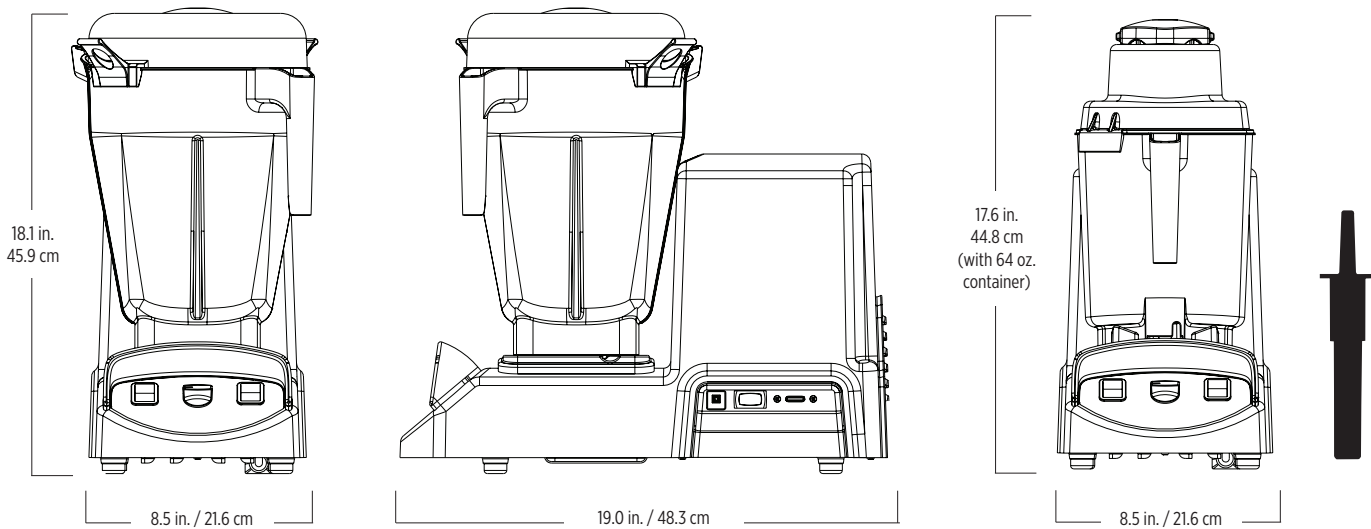

ITEM #	DESCRIPTION
5201	Vitamix XL Variable Speed with 1.5 gal. / 5.6 L container complete with XL blade assembly, lid, and tamper. Also includes 64 oz. / 2.0 L container complete with XL blade assembly and lid.
5205	Vitamix XL Variable Speed with 1.5 gal. / 5.6 L container complete with blade assembly, lid, and tamper.

SPECIFICATIONS:

Motor: ≈4.2 peak output horsepower motor

Electrical: 120 V, 50/60 Hz, 15.0 A

Container & Blade: 1.5 gal. / 5.6 L and 64 oz. / 2.0 L high-impact clear / stackable container complete with XL blade assembly and lid

Dimensions (H x W x D):
18.1 x 8.5 x 19.0 in. / 45.9 x 21.6 x 48.3 cm

Certifications: 

SHIPPING:

Pack: 1 per standard pack

Carton Dimensions (H x W x D):
18.5 x 15.8 x 35.5 in. / 47.0 x 40.0 x 90.0 cm

Weight: 45.5 lbs.

Case Cube: 6.0 cu. ft. / 0.17 cu. m

WARRANTY: The Vitamix XL is backed by a three-year warranty on motor base parts and a one-year warranty on labor. For more complete warranty terms and conditions, please call 1.800.437.4654 or visit vitamix.com.

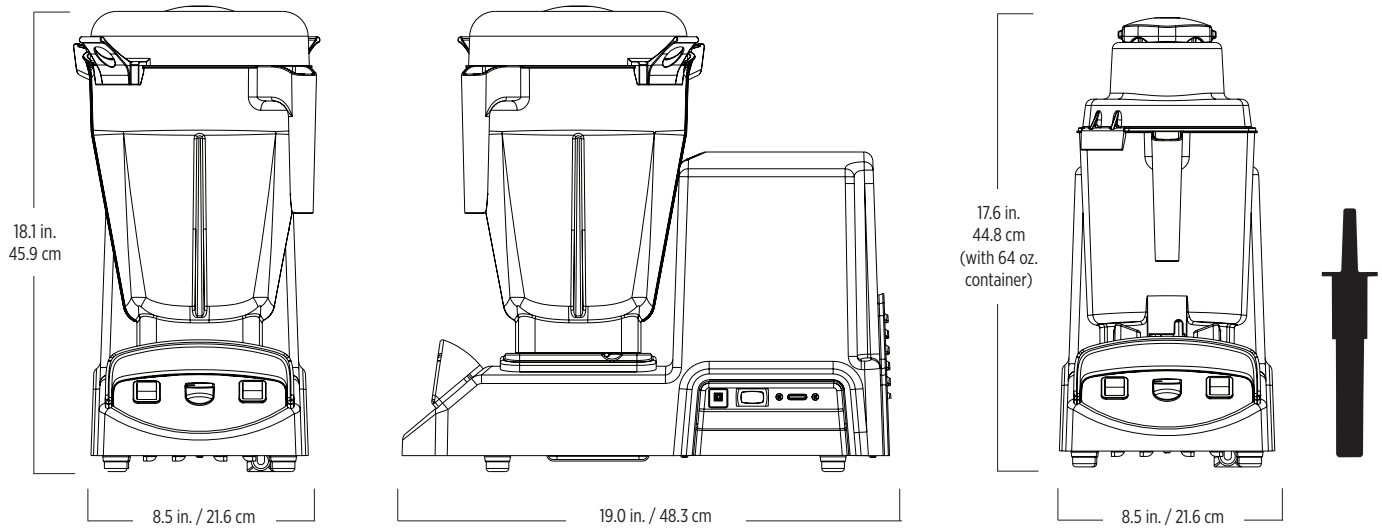

ITEM #	DESCRIPTION
5202	Vitamix XL Programs with 1.5 gal. / 5.6 L container complete with XL blade assembly, lid, and tamper. Also includes 64 oz. / 2.0 L container complete with XL blade assembly, and lid. Includes 6 - preloaded programs.

SPECIFICATIONS:

Programs: 6

Motor: ≈4.2 peak output horsepower motor

Electrical: 120 V, 50/60 Hz, 15.0 A

Container & Blade: 1.5 gal. / 5.6 L and 64 oz. / 2.0 L high-impact clear / stackable container complete with XL blade assembly and lid

Dimensions (H x W x D):
18.1 x 8.5 x 19.0 in. / 45.9 x 21.6 x 48.3 cm

Certifications:  

SHIPPING:

Pack: 1 per standard pack

Carton Dimensions (H x W x D):
18.5 x 15.8 x 35.5 in. / 47.0 x 40.0 x 90.0 cm

Weight: 45.5 lbs.

Case Cube: 6.0 cu. ft. / 0.17 cu. m

WARRANTY: The Vitamix XL is backed by a three-year warranty on motor base parts and a one-year warranty on labor. For more complete warranty terms and conditions, please call 1.800.437.4654 or visit vitamix.com.



FROZEN TREAT

Mixers



MIX'N MACHINE® ADVANCE™

Programmed incorporating of mix-ins into ice cream and frozen yogurt



MIX'N MACHINE®

Standard incorporating of mix-ins into ice cream and frozen yogurt

Applications	Frozen desserts with mix-ins	Frozen desserts with mix-ins
Motor	500 - 3000 RPM	3440 RPM
Included Container	N/A	N/A
Controls Automated Processing	6 programmed settings with gradual acceleration	
Activation Pulse	Cup-activated lever Pulse	On/Off Switch
Accessories	Variety of agitators available for different applications	Variety of agitators available for different applications

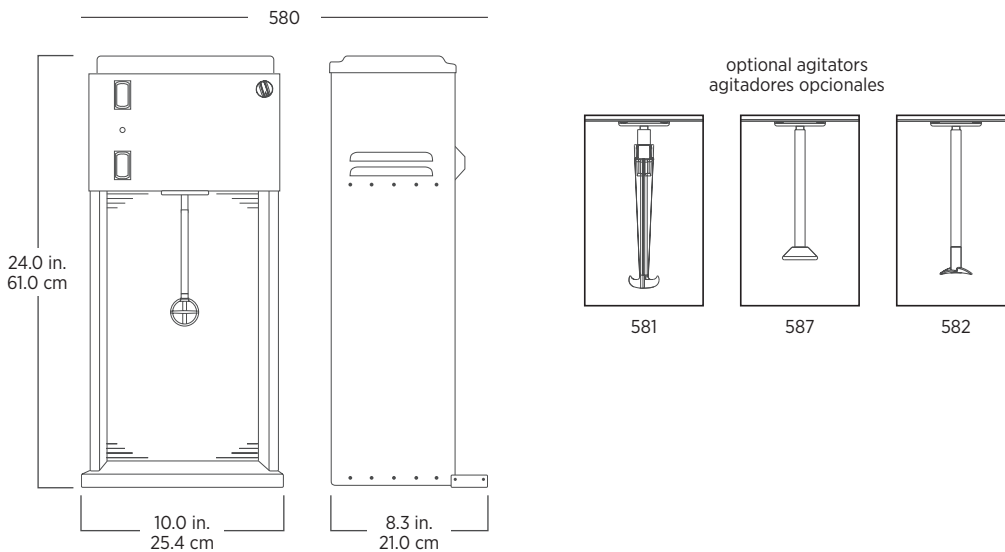

ITEM #	DESCRIPTION
580	Mix'n Machine Advance with permanent soft ice cream agitator. Includes 6 pre-loaded programs.
581	Mix'n Machine Advance with removable / reusable agitator, includes 10 removable agitators. Includes 6 pre-loaded programs.
582	Mix'n Machine Advance with aggressive / permanent hard ice cream agitator. Includes 6 pre-loaded programs.
587	Mix'n Machine Advance with permanent soft ice cream cone-shaped agitator. Includes 6 pre-loaded programs.

SPECIFICATIONS:

Programs: 6

Motor: 500-3000 RPM bare motor speed

Electrical: 120 V, 50/60 Hz, 1.6 A

Dimensions (H x W x D):

24.0 x 10.0 x 8.3 in. / 61.0 x 25.4 x 21.0 cm

Certifications: cULus NSF

SHIPPING:

Pack: 1 per standard pack

Carton Dimensions (H x W x D):

13.0 x 11.0 x 28.0 in. / 33.0 x 27.9 x 71.1 cm

Weight: 25.0 lbs.

Case Cube: 1.9 cu. ft. / 0.05 cu. m

WARRANTY: The Mix'n Machine Advance is backed by a three-year warranty on motor base parts and a one-year warranty on labor. For more complete warranty terms and conditions, please call 1.800.437.4654 or visit vitamix.com.

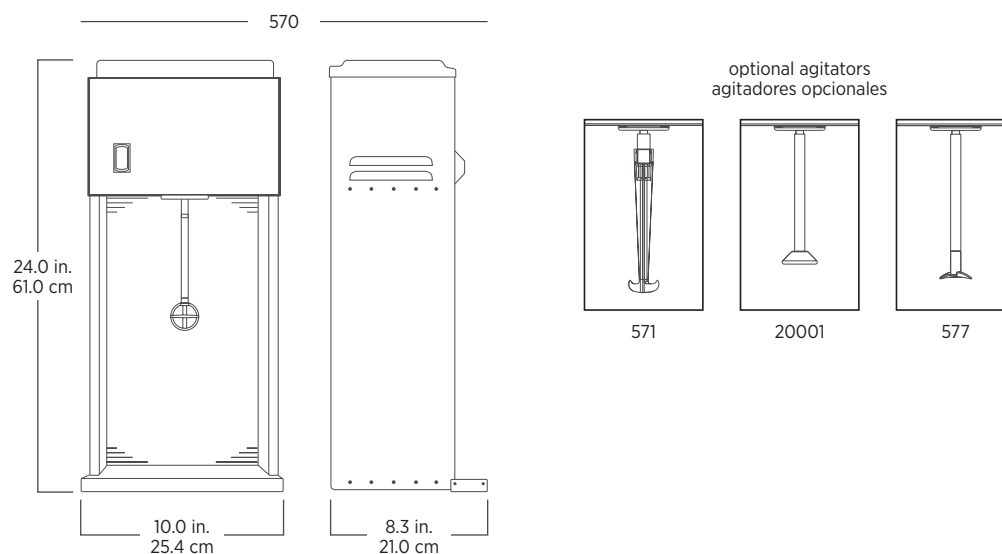

ITEM #	DESCRIPTION
570	Mix'n Machine On-Counter with permanent soft ice cream agitator.
571	Mix'n Machine On-Counter with removable / reusable agitator, includes 10 removable agitators.
577	Mix'n Machine On-Counter with aggressive / permanent hard ice cream agitator.
20001	Mix'n Machine On-Counter with permanent soft ice cream cone-shaped agitator.

SPECIFICATIONS:

Motor: 3440 RPM bare motor speed

Electrical: 120 V, 50/60 Hz, 2.6 A

Dimensions (H x W x D):

24.0 x 10.0 x 8.3 in. / 61.0 x 25.4 x 21.0 cm

Certifications: cUL_{US} NSF

SHIPPING:

Pack: 1 per standard pack

Carton Dimensions (H x W x D):

13.0 x 11.0 x 28.0 in. / 33.0 x 28.0 x 71.1 cm

Wall-Mount: 14.4 x 10.0 x 18.9 in. / 36.6 x 25.4 x 48.0 cm

Weight: 25.0 lbs.

Case Cube: 1.9 cu. ft. / 0.05 cu. m

WARRANTY: The Mix'n Machine is backed by a three-year warranty on motor base parts and a one-year warranty on labor. For more complete warranty terms and conditions, please call 1.800.437.4654 or visit vitamix.com.

EFFICIENT Blends

Each Vitamix container is designed to efficiently move ingredients toward the blades, for faster speed of service and higher quality blends. Explore our full range of containers on the following pages.

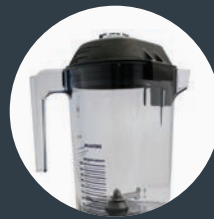

Containers

- 32. Advance® Containers
- 34. Standard Containers
- 36. Specialty Containers



Container compatibility at a glance

Find your machine in the chart below to see compatible containers.

The Right Equipment



For food or beverage applications, from front-of-house to back, we've got the right machines for your business. Each Vitamix container is designed to efficiently move ingredients into the blades, for faster speed of service and higher quality blends.









		COVERED BEVERAGE BLENDING	
		The Quiet One®	Touch & Go Advance
Advance Containers	48-ounce	✓	
	32-ounce	✓	✓
Standard Containers	64-ounce		
	48-ounce	✓	✓
	32-ounce	✓	✓
Specialty Containers	32-ounce Aerating	✓	✓
	1.5-gallon XL		
	64-ounce XL		

 = Container comes standard with the machine |
  = Container is compatible with the machine and available for purchase







- *Covered Beverage Blending* – Our quietest blenders help to provide a pleasing atmosphere for your customers.
- *Uncovered Beverage Blending* – These machines offer power and durability for the front of the house.
- *Food Preparation Blending* – Our back-of-house machines are built to perform in the toughest kitchen environments.







UNCOVERED BEVERAGE BLENDING		FOOD PREPARATION BLENDING		
				
Drink Machine™ Advance®	Drink Machine™ Two Speed	Vita-Prep® 3	Vita-Prep®	XL® Variable Speed XL® Programs
✓				
✓				
✓	✓	✓	✓	
✓	✓	✓	✓	
✓	✓	✓	✓	
		✓	✓	
				✓
				✓







48-OUNCE ADVANCE CONTAINERS

		
	Complete	Container Only
	48 oz. / 1.4 L BPA-Free, Advance container complete with Advance blade assembly and lid. NSF certified. 2.2 lbs. / 1.0 kg Dimensions (H x W x D): 8.6 x 7.1 x 8.1 in. / 21.9 x 18.0 x 20.6 cm	48 oz. / 1.4 L BPA-Free, Advance container only, no blade assembly, no lid. NSF certified. 1.0 lbs. / 0.5 kg Dimensions (H x W x D): 8.6 x 7.1 x 8.1 in. / 21.9 x 18.0 x 20.6 cm
	Item #: 15978	Item #: 16016
	Item #: 58988	Item #: 60048
	Item #: 58989	Item #: 60049
	Item #: 58990	Item #: 60050
	Item #: 58991	Item #: 60051



32-OUNCE ADVANCE CONTAINERS

		
	Complete	Container Only
	32 oz. / 0.9 L BPA-Free, Advance container complete with Advance blade assembly and lid. NSF certified. 2.2 lbs. / 1.0 kg. Dimensions (H x W x D): 8.6 x 7.1 x 8.1 in. / 21.9 x 18.0 x 20.6 cm	32 oz. / 0.9 L BPA-Free, Advance container only, no blade assembly, no lid. NSF certified. 1.0 lb. / 0.5 kg. Dimensions (H x W x D): 8.6 x 7.1 x 8.1 in. / 21.9 x 18.0 x 20.6 cm
	Item #: 15981	Item #: 16019
	Item #: 58984	Item #: 60044
	Item #: 58985	Item #: 60045
	Item #: 58986	Item #: 60046
	Item #: 58987	Item #: 60047

					
Rubber Lid with Plug	One Piece Lid	Splash Lid Tethered Plug	Retainer Nut	Lid Plug	Advance Blade Assembly
Rubber lid with lid plug, for Advance container. 7.2 oz. / 0.2 kg	One piece rubber lid, for Advance container. 7.2 oz. / 0.2 kg	Rubber splash lid with tethered lid plug, for Advance container. 6.0 oz. / 0.2 kg	Advance retainer nut, for Advance container. 3.6 oz. / 0.1 kg	Lid plug, for Advance container. 0.8 oz. / 0.02 kg	Advance blade assembly, for use with Advance container only. 8.5 oz. / 0.3 kg
Item #: 15985	Item #: 16090	Item #: 15092	Item #: 15585	Item #: 15987	Item #: 15990
N/A	Item #: 58992	Item #: 58996	N/A	N/A	Item #: 15990
N/A	Item #: 58993	Item #: 58997	N/A	N/A	Item #: 15990
N/A	Item #: 58994	Item #: 58998	N/A	N/A	Item #: 15990
N/A	Item #: 58995	Item #: 58999	N/A	N/A	Item #: 15990

					
Rubber Lid with Plug	One Piece Lid	Splash Lid Tethered Plug	Retainer Nut	Lid Plug	Advance Blade Assembly
Rubber lid with lid plug, for Advance container. 7.2 oz. / 0.2 kg	One piece rubber lid, for Advance container. 7.2 oz. / 0.2 kg	Rubber splash lid with tethered lid plug, for Advance container. 6.0 oz. / 0.2 kg	Advance retainer nut, for Advance container. 3.6 oz. / 0.1 kg	Lid plug, for Advance container. 0.8 oz. / 0.02 kg	Advance blade assembly, for use with Advance container only. 8.5 oz. / 0.3 kg
Item #: 15985	Item #: 16090	Item #: 15092	Item #: 15585	Item #: 15987	Item #: 15990
N/A	Item #: 58992	Item #: 58996	N/A	N/A	Item #: 15990
N/A	Item #: 58993	Item #: 58997	N/A	N/A	Item #: 15990
N/A	Item #: 58994	Item #: 58998	N/A	N/A	Item #: 15990
N/A	Item #: 58995	Item #: 58999	N/A	N/A	Item #: 15990

64-OUNCE STANDARD CONTAINERS





		
	Complete	Container Only
	<p>64 oz. / 2.0 L BPA-Free, clear container with wet blade assembly and lid. NSF certified. 3.2 lbs. / 1.5 kg. Dimensions (H x W x D): 13.4 x 7.6 x 9.1 in. / 34.0 x 19.3 x 23.1 cm</p>	<p>64 oz. / 2.0 L BPA-Free, clear container only, no blade assembly, no lid. NSF certified. 2.4 lbs. / 1.1 kg. Dimensions (H x W x D): 13.4 x 7.6 x 9.1 in. / 34.0 x 19.3 x 23.1 cm</p>
Item #: 1195		Item #: 58625
Yellow Allergen Container	Item #: 67403	Item #: 67404



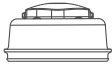

48-OUNCE STANDARD CONTAINERS





		
	Complete	Container Only
	<p>48 oz. / 1.4 L BPA-Free, clear / stackable container with wet blade assembly and lid. NSF certified. 2.0 lbs. / 0.9 kg. Dimensions (H x W x D): 13.4 x 7.6 x 9.1 in. / 34.0 x 19.3 x 23.1 cm</p>	<p>48 oz. / 1.4 L BPA-Free, clear / stackable container only, no blade assembly, no lid. NSF certified. 1.3 lbs. / 0.6 kg. Dimensions (H x W x D): 13.4 x 7.6 x 9.1 in. / 34.0 x 19.3 x 23.1 cm</p>
Item #: 15504		Item #: 58805

32-OUNCE STANDARD CONTAINERS

		
	Complete	Container Only
	<p>32 oz. / 0.9 L compact BPA-Free, clear / stackable container with wet blade assembly and lid. NSF certified. 2.6 lbs. / 1.2 kg. Dimensions (H x W x D): 13.4 x 7.6 x 9.1 in. / 34.0 x 19.3 x 23.1 cm</p>	<p>32 oz. / 0.9 L compact BPA-Free, clear / stackable container only, no blade assembly, no lid. NSF certified. 1.8 lbs. / 0.8 kg. Dimensions (H x W x D): 13.4 x 7.6 x 9.1 in. / 34.0 x 19.3 x 23.1 cm</p>
Item #: 15652		Item #: 15643

				
Two Piece Lid	Retainer Nut	Lid Plug	Wet Blade	Tamper
Two-piece thermoplastic rubber lid with lid plug, for 64 oz. / 2.0 L container. 7.2 oz. / 0.2 kg	Retainer nut, for standard containers (32 oz. / 0.9 L – 48 oz. / 1.4 L – 64 oz. / 2.0 L). 1.0 lb. / 0.5 kg	Lid plug, for 64 oz. / 2.0 L high-impact, clear container. 1.6 oz. / 0.05 kg	Wet blade assembly. 6.4 oz. / 0.2 kg	Tamper. 3.2 oz. / 0.1 kg
Item #: 1191	Item #: 836	Item #: 62984	Item #: 1152	Item #: 760
Item #: 067405	N/A	N/A	N/A	N/A



				
Two Piece Lid	Retainer Nut	Lid Plug	Wet Blade	Tamper
Two-piece thermoplastic rubber lid with plug, for 48 oz. / 1.4 L polycarbonate container. 4.8 oz. / 0.1 kg	Retainer nut, for standard containers (32 oz. / 0.9 L – 48 oz. / 1.4 L – 64 oz. / 2.0 L). 1.0 lb. / 0.5 kg	Lid plug for 48 oz. / 1.4 L high-impact, clear / stackable container. 0.8 oz. / 0.02 kg	Wet blade assembly. 6.4 oz. / 0.2 kg	Tamper. 3.2 oz. / 0.1 kg
Item #: 15507	Item #: 836	Item #: 15987	Item #: 1152	Item #: 760

				
Two Piece Lid	Retainer Nut	Lid Plug	Wet Blade	Tamper
Two-piece thermoplastic rubber lid with plug, for 32 oz. / 0.9 L compact high-impact, clear / stackable container. 5.7 oz. / 0.2 kg	Retainer nut, for standard containers (32 oz. / 0.9 L – 48 oz. / 1.4 L – 64 oz. / 2.0 L). 1.0 lb. / 0.5 kg	Lid plug for 32 oz. / 0.9 L compact container lid only. 1.7 oz. / 0.05 kg	Wet blade assembly. 6.4 oz. / 0.2 kg	Tamper. 3.2 oz. / 0.1 kg
Item #: 15647	Item #: 836	Item #: 15851	Item #: 1152	Item #: 760



Smart Product Design

- 1.5-gallon XL container allows you to blend up to 24 servings in a single blend, minimizing prep time and improving speed of service.
- With shatter-proof polycarbonate and a hardened stainless-steel blade, XL containers are built to last.
- The vented lid plug releases steam, allowing you to blend hot mixtures and add ingredients while processing.





1.5-GALLON FOR XL





		
	Complete	Container Only
	1.5 gal. / 5.6 L container complete with XL blade assembly, lid and lid plug. For use with Vitamix XL only. NSF certified. Dimensions (H x W x D): 13.5 x 12.1 x 12.1 in. / 34.3 x 30.7 x 30.7 cm	1.5 gal. / 5.6 L container only, no blade assembly, no lid, no lid plug. For use with Vitamix XL only. NSF certified. Dimensions (H x W x D): 12.1 x 8.8 x 12.1 in. / 30.7 x 22.4 x 30.7 cm
	Item #: 15899	Item #: 15896

64-OUNCE FOR XL

		
	Complete	Container Only
	64 oz. / 2.0 L container complete with XL blade assembly, lid and lid plug. For use with Vitamix XL only. NSF certified. Dimensions (H x W x D): 13.1 x 7.1 x 8.2 in. / 33.3 x 18.0 x 20.8 cm	64 oz. / 2.0 L container only, no blade assembly, no lid, no lid plug. For use with Vitamix XL only. NSF certified. Dimensions (H x W x D): 8.6 x 7.1 x 8.2 in. / 21.8 x 18.0 x 20.8 cm
	Item #: 15894	Item #: 15893



				
Two Piece Lid	Retainer Nut	Lid Plug	XL Blade for use with 1.5-gallon container	Tamper
Lid and lid plug, for use with Vitamix XL 1.5 gal. / 5.6 L container only. Dimensions (H x W x D): 3.9 x 12.1 x 8.5 in. / 9.9 x 30.7 x 21.6 cm	1.5 gal. / 5.6 L retainer nut. For use with Vitamix XL only.	Lid plug for use with Vitamix XL 1.5 gal. / 5.6 L container only. 1.6 oz. / 0.1 kg	Blade assembly, for use with Vitamix XL 1.5 gal. / 5.6 L container only.	Tamper. 3.2 oz. / 0.1 kg
Item #: 15900	Item #: 15901	Item #: 62984	Item #: 15897	Item #: 760

				
Two Piece Lid	Retainer Nut	Lid Plug	XL Blade for use with 64-ounce container	Tamper
Lid and lid plug, for use with Vitamix XL 64 oz. / 2.0 L container only. Dimensions (H x W x D): 6.4 x 7.0 x 5.9 in. / 16.3 x 17.8 x 15.0 cm	Retainer nut, for use with Vitamix XL 64 oz. / 2.0 L container only.	Lid plug for use with Vitamix XL 64 oz. / 2.0 L container only. 1.6 oz. / 0.1 kg	Blade assembly, for use with Vitamix XL 64 oz. / 2.0 L container only	Tamper. 3.2 oz. / 0.1 kg
Item #: 15892	Item #: 15942	Item #: 62984	Item #: 15941	Item #: 760



FINESSE DELICATE

Blends

Sometimes, the most powerful thing you can be is gentle.





Our Aerating Container is ideal for fine-tuning delicate blends like emulsions, culinary foams, whipped cream, and more. From oxidizing citrus juice to making large batches of foam, the disc blade delivers an easy way to create new textures in the kitchen.

Smart Product Design

- Disc blade design creates dense and pourable culinary foam, flavored whipped cream, mousse, infusions, and emulsions with minimal splashing.
- BPA-Free Eastman Tritan™ copolyester and double-sealed bearings provide strength and durability.
- Provides the flexibility to blend at a variety of speed settings.
- Compatible with The Quiet One®, Blending Station® Advance®, Vita-Prep®, and Vita-Prep® 3.



32-OUNCE AERATING CONTAINER

Complete	Item #: 62947		32 oz. / 0.9 L compact BPA-Free, clear / stackable container with aerating blade assembly, lid and mini tamper. NSF certified. 2.6 lbs. / 1.2 kg. Dimensions (H x W x D): 13.4 x 7.6 x 9.1 in. / 34.0 x 19.3 x 23.1 cm
Retainer Nut	Item #: 836		Retainer nut, for standard containers (32 oz. / 0.9 L – 48 oz. / 1.4 L – 64 oz. / 2.0 L). 1.0 lb. / 0.5 kg
Two Piece Lid	Item #: 15647		Two-piece thermoplastic rubber lid with plug, for 32 oz. / 0.9 L compact high-impact, clear / stackable container. 5.7 oz. / 0.2 kg
Lid Plug	Item #: 15851		Lid plug for 32 oz. / 0.9 L compact container lid only. 1.7 oz. / 0.05 kg
Mini Tamper	Item #: 15033		Mini Tamper. 3.2 oz. / 0.1 kg

FIND YOUR Accessories

From accessories to replacement parts, we offer everything you need to keep your machine performing at its highest level, day after day, for years to come.



Accessories & Parts

44. Rinsers

45. Sound Enclosures

45. Programming

45. Centering Pads

46. Drive Sockets, Repair Kits

47. Mix'n Machine®



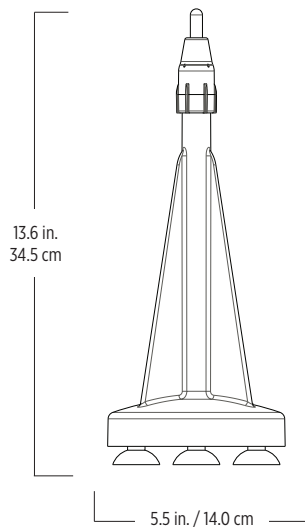

ITEM #	DESCRIPTION
1442	Rinse-O-Matic blender container rinser, includes base, 2.5 ft. / 76.2 cm hose assembly, Y connector, faucet adapters and instructions.
1445	Carton of 12 Rinse-O-Matic blender container rinsers.

SPECIFICATIONS:

PSI: Cold water from a faucet with a minimum 25 psi / maximum 80 psi of pressure

Dimensions (H x W x D):
13.6 x 5.5 in. / 34.5 x 14.0 cm

Certifications: NSF

SHIPPING:

Pack: 1442: 1 per standard pack
1445: 12 per standard pack

Carton Dimensions (H x W x D):
1442: 14.0 x 6.8 x 6.8 in. / 35.6 x 17.3 x 17.3 cm
1445: 14.5 x 20.5 x 27.5 in. / 36.8 x 52.1 x 69.9 cm

Weight: 1442: 2.2 lbs.
1445: 31.0 lbs

Case Cube: 1442: 0.4 cu. ft. / 0.01 cu. m
1445: 4.7 cu. ft. / 0.1 cu. m

WARRANTY: The Rinse-O-Matic is backed by a one-year warranty on parts. For more complete warranty terms and conditions, please call 1.800.437.4654 or visit vitamix.com.

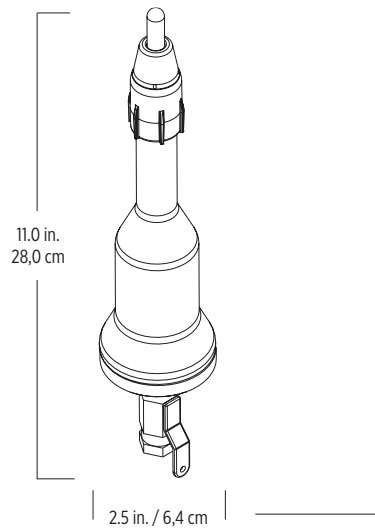

ITEM #	DESCRIPTION
1462	Sink Mount Rinse-o-matic - includes Rinse-o-matic blender container rinsing base, valve, and instructions.

SPECIFICATIONS:

PSI: Cold water from a faucet with a minimum 25 psi / maximum 80 psi of pressure

Dimensions: (H x W x D):
11.0 x 2.5 x 2.5 in. / 28,0 x 6,4 x 6,4 cm

SHIPPING:

Pack: 1 per standard pack

Carton Dimensions: (H x W x D):
14.0 x 6.8 x 6.8 in. / 35.6 x 17.3 x 17.3 cm

Weight: 0.91 lbs.

Case Cube: 0.4 cu. ft. / 0.01 cu. m





WARRANTY: The Sink Mount Rinse-o-matic® is backed by a one-year warranty on parts. For more complete warranty terms and conditions, please call 1.800.437.4654 or visit vitamix.com.

NOTE: A 1 3/4" diameter hole must be drilled in sink to allow for installation.

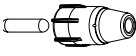

Find Your Accessories

Locate your machine in the following charts to find replacement parts and compatible accessories.

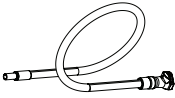

RINSERS — REPLACEMENT PARTS

Rinse-O-Matic®	Item #: 1415		Faucet adapter kit, includes various adapters – 5 per standard pack. 2.3 oz. / 0.1 kg
Rinse-O-Matic®	Item #: 1419		Y faucet connector. 4.9 oz. / 0.1 kg
Rinse-O-Matic®	Item #: 1437		Quick disconnect insert (male). 0.5 oz. / 0.01 kg
Rinse-O-Matic® In Sink Rinse-o-matic®	Item #: 1443		Rinse-O-Matic sprayhead / activator replacement kit, includes sprayhead and valve assembly. 0.64 oz. / 0.02 kg
Rinse-O-Matic®	Item #: 1444		Feet replacement kit, includes rubber suction cup feet – 3 per standard pack. 0.4 oz. / 0.01 kg
Rinse-O-Matic®	Item #: 1448		Rinse-O-Matic hose assembly replacement kit, includes 2.5 ft. / 76.2 cm clear PVC hose, and 2 connectors. 5.4 oz. / 0.2 kg





SOUND ENCLOSURES — REPLACEMENT PARTS

The Quiet One (Twist Lock) Touch & Go Advance	Item #: 067879		Complete two-piece Twist Lock copolyester plastic compact cover with removable cover hinge. For The Quiet One, The Quiet One Twist Lock and Touch & Go Advance only. 1,8 kg. Dimensions (H x W x D): 33,8 x 30,7 x 61,5 cm
	Item #: 067877		Twist Lock copolyester plastic compact cover back only. For The Quiet One, The Quiet One Twist Lock and Touch & Go Advance only. 0,73 kg. Dimensions (H x W x D): 33,8 x 30,7 x 61,5 cm
	Item #: 15081		Copolyester plastic compact cover door only. For The Quiet One only. 2,4 lbs. / 1,1 kg. Dimensions (H x W x D): 13,3 x 12,1 x 24,2 in. / 33,8 x 30,7 x 61,5 cm



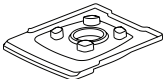



PROGRAMMING — REPLACEMENT PARTS

The Quiet One® Drink Machine™ Advance® XL® Programs	Item #: 15606		Programmer software kit for the TQO, DMA, and XL Programs. Includes USB cable with programming module, instruction manual and CD. (Not compatible with Apple/Mac)
	Item #: 15644		Extra program chip for programmer software kit. Note: Specify custom program needed if necessary.
	Item #: 15645		Extra program chips for programmer software kit – 10 per standard package. Note: Specify custom program needed if necessary.

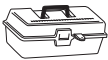



CENTERING PADS — REPLACEMENT PARTS

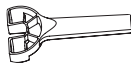



The Quiet One (Twist Lock) Touch & Go Advance	Item #: 067876		Sound-reducing centering pad, for TQO (Twist Lock) and Touch & Go Advance. 0,1 kg
Drink Machine™ Advance®	Item #: 15578		Sound-reducing centering pad, for Drink Machine Advance. 3,5 oz. / 0,1 kg
Drink Machine™ Two-Speed Vita-Prep® 3 Vita-Prep®	Item #: 791		Sound-reducing centering pad. 4,0 oz. / 0,11 kg
XL® Variable Speed XL® Programs	Item #: 15895		Sound-reducing centering pad, for Vitamix XL, 1 per standard pack. 3,5 oz. / 1kg

DRIVE SOCKET, REPAIR KITS – REPLACEMENT PARTS

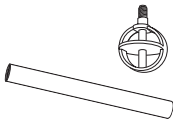
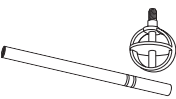
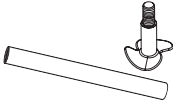
<p>The Quiet One® Drink Machine™ Advance® Drink Machine™ Two-Speed Vita-Prep® 3 Vita-Prep®</p>	<p>Item #: 15519</p>		<p>Repair kit with tool box, includes 5 drive sockets, retainer nut wrench, silicone sealant tube, Allen wrench, and maintenance manual. 3.0 lbs. / 1.4 kg</p>
<p>The Quiet One® Drink Machine™ Advance® Drink Machine™ Two-Speed Vita-Prep® 3 Vita-Prep®</p>	<p>Item #: 891</p>		<p>Drive socket kit with 1 drive socket, includes Allen wrench and instructions. 1.6 oz. / 0.05 kg</p>
	<p>Item #: 15546</p>		<p>Drive socket kit with 2 drive sockets, includes Allen wrench and instructions. 2.0 oz. / 0.06 kg</p>
	<p>Item #: 15547</p>		<p>Drive socket kit with 5 drive sockets, includes Allen wrench and instructions. 4.0 oz. / 0.1 kg</p>
<p>XL® Variable Speed XL® Programs</p>	<p>Item #: 15902</p>		<p>Drive socket kit with 1 drive socket, includes Allen wrench and instructions. For use with Vitamix XL only. 1.6 oz. / 0.05 kg</p>
	<p>Item #: 15903</p>		<p>Drive socket kit with 2 drive sockets, includes Allen wrench and instructions. For use with Vitamix XL only. 2.0 oz. / 0.06 kg</p>
	<p>Item #: 15904</p>		<p>Drive socket kit with 5 drive sockets, includes Allen wrench and instructions. For use with Vitamix XL only. 4.0 oz. / 0.11 kg</p>
<p>The Quiet One® Drink Machine™ Advance® Drink Machine™ Two-Speed Vita-Prep® 3 Vita-Prep® XL® Variable Speed XL® Programs</p>	<p>Item #: 15596</p>		<p>Retainer nut wrench, plastic. 3.2 oz. / 0.1 kg</p>

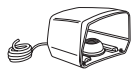
MIX'N MACHINE® | MIX'N MACHINE® ADVANCE® – REPLACEMENT PARTS

Mix'n Machine® Mix'n Machine® Advance®	Item #: 30019		Permanent soft ice cream agitator. 0.8 oz. / 0.02 kg
Mix'n Machine® Mix'n Machine® Advance®	Item #: 30060		Permanent soft ice cream cone-shaped agitator. 0.8 oz. / 0.02 kg
Mix'n Machine® Mix'n Machine® Advance®	Item #: 30003		Removable agitators – 10 per standard pack. 0.4 oz. / 0.01 kg Note: Must be used with removable agitator shaft.
Mix'n Machine® Mix'n Machine® Advance®	Item #: 30018		Aggressive / permanent hard ice cream agitator. 0.8 oz. / 0.02 kg
Mix'n Machine® Mix'n Machine® Advance®	Item #: 80		Conversion kit: permanent soft / hard ice cream agitator to removable / reusable agitator. Contains 1 removable agitator shaft. 2.5 oz. / 0.07 kg
Mix'n Machine® Mix'n Machine® Advance®	Item #: 81		Conversion kit for on-counter models: removable / reusable agitator to permanent soft ice cream agitator. Contains 1 permanent soft ice cream agitator (#30019), and 1 countertop agitator shaft (#30023). 2.5 oz. / 0.1 kg
Mix'n Machine®	Item #: 30004		Conversion kit for wall-mount models: removable / reusable agitator to permanent soft ice cream agitator. Contains 1 permanent soft ice cream agitator (#30019), and 1 wall mount agitator shaft (#30034). 3.0 oz. / 0.1 kg
Mix'n Machine® Mix'n Machine® Advance®	Item #: 30006		Conversion kit: removable / reusable agitator to aggressive / permanent hard ice cream agitator. Contains 1 permanent hard ice cream agitator (#30018), and 1 countertop agitator shaft (#30023). 3.4 oz. / 0.1 kg

MIX'N MACHINE® MIX'N MACHINE® ADVANCE® – REPLACEMENT PARTS			
Mix'n Machine®	Item #: 30000		Guarded air-activated foot control for 120 V models only. 2.2 lbs. / 0.1 kg
Mix'n Machine® Mix'n Machine® Advance®	Item #: 30015		Splash guard for on-counter models. 9.5 oz. / 0.3 kg
Mix'n Machine®	Item #: 30029		Moving splash guard for wall-mount models. 9.5 oz. / 0.3 kg
Mix'n Machine® Mix'n Machine® Advance®	Item #: 30023		Agitator shaft for standard on-counter models.
Mix'n Machine® Mix'n Machine® Advance®	Item #: 15668		Wall mounting (bracket) kit. 2.0 lbs / 0.9 kg

